



HEIDENHAIN

araxe

72, rue Yves le Coz
78000 VERSAILLES

tél : 01 30 21 48 49
fax : 01 39 51 16 33

<http://www.araxe.com>
contact@araxe.com

HEIDENHAIN



Product Information

VS 101

Camera System for
Workspace Monitoring

VS 101

Camera system for workspace monitoring

Together with the VS 101 camera system and the control option VSC (Visual Setup Control), the TNC 640 can automatically monitor the clamping and machining situation in the machine's workspace.

Design and mounting

The VS 101 sealed camera system is designed for integration into the machine's workspace. It is mounted directly on the machine's milling head or headstock. The VS 101 camera system consists of an industrial camera and a sturdy protective housing. The protective housing features a lens cover and connections for sealing air to prevent the camera optics from being damaged.

The camera system is available with various lenses to make it possible to adjust the field of view and the distance of the camera to the circumstances of the machine.

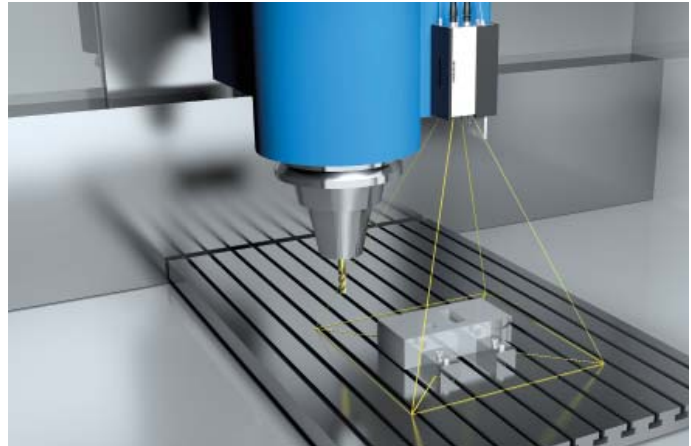

Figure 1: Image acquisition with the VS 101 camera system

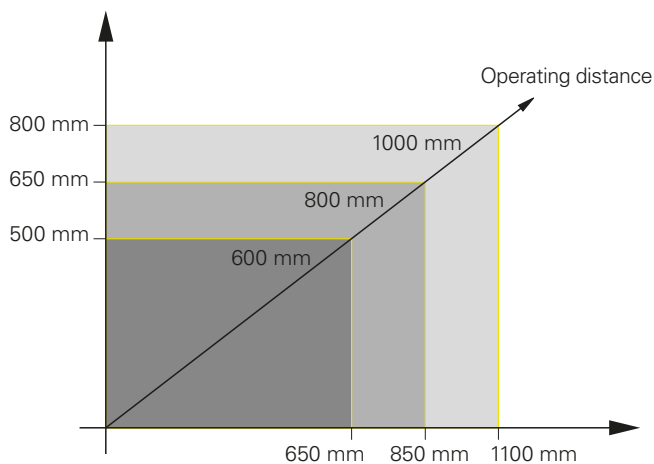

Figure 2: Field of view with 6 mm lens

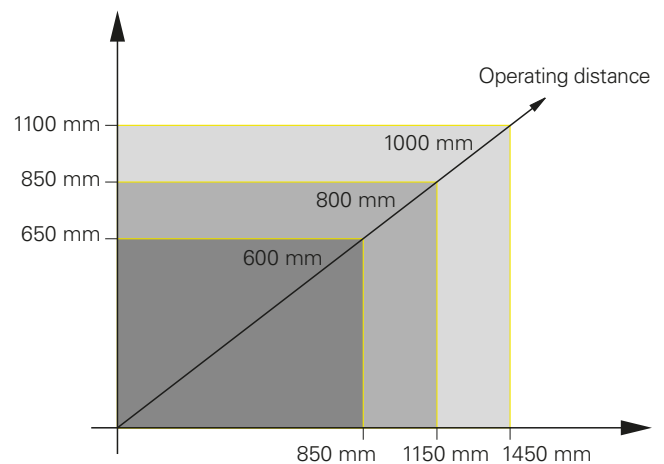

Figure 3: Field of view with 4.5 mm lens

Test procedure

The VSC option enables the TNC 640 to run a nominal-to-actual value comparison and detect faulty situations in the workspace. With this option, reference photos are taken by the VS 101 camera system and are then compared with the photos of the subsequent parts. VSC first opens the lens cover immediately before taking the picture. When the cover is open, sealing air prevents the ingress of chips, coolant, or swarf. The cover is opened and closed by an integrated cylinder that can be controlled by a conventional compressed-air valve. The DA 400 is necessary to provide for the sealing air and air-curtain. The VS 101 camera system features an integrated sensor that informs the control about the status of the protective cover.



VSC is capable of detecting and documenting the following situations:

- Missing machining operations or faulty workpieces
- Clamping situation for recurring jobs
- Missing fixtures or tools forgotten in the workspace

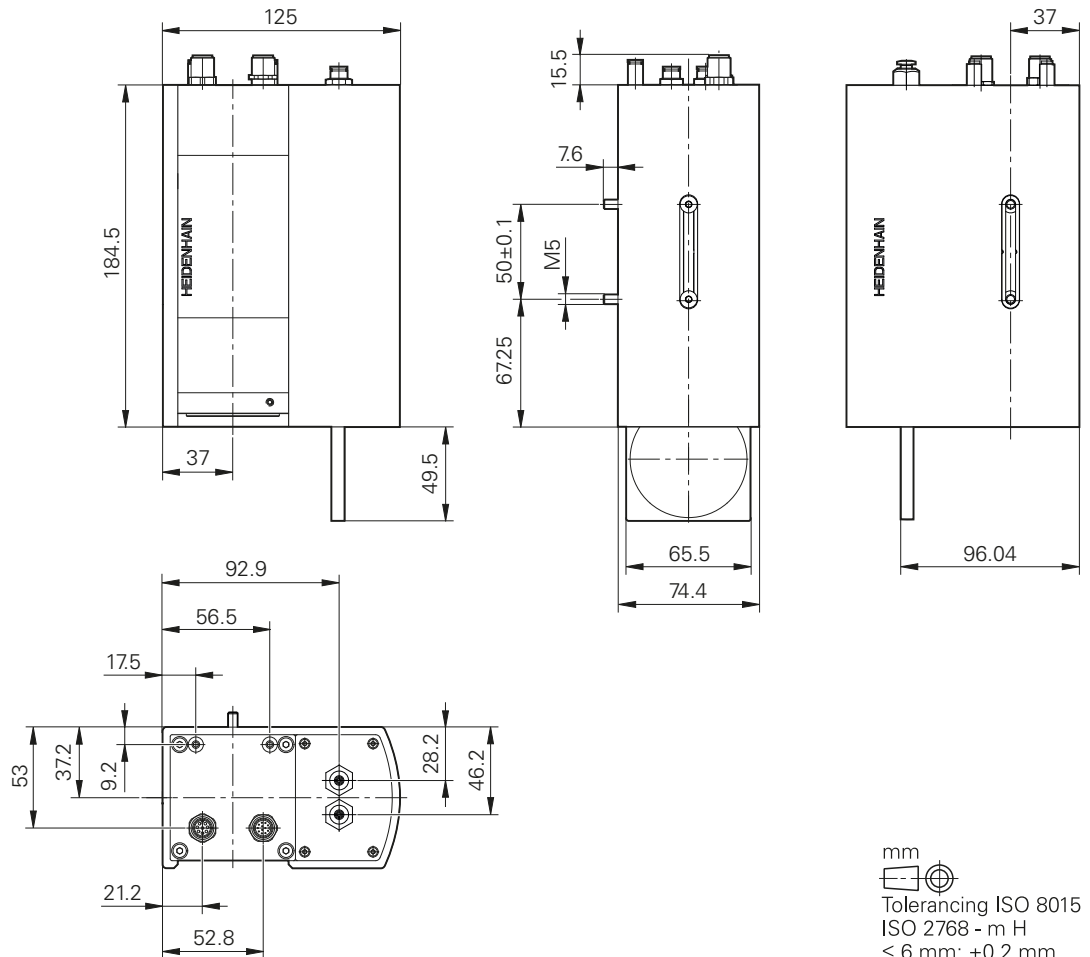

Specifications	VS 101 camera system
Area of application	Machine tool workspace monitoring
Fastening	Screw fastening on spindle housing
Type of camera	Monochrome industrial camera (1.31 megapixels) with Gigabit Ethernet interface
Focusing	By depth of focus (manually adjustable during initial servicing)
Objective lens	Prime lens: 6 mm or 4.5 mm
Field of view	See Figures 2 and 3
Operating distance	See Figures 2 and 3
Illumination of object	By existing workspace illumination
Protection EN 60529	IP 46 when not in operation, closed IP X2 during image acquisition and opened protective cover, if the housing is inclined up to 15° (X: no information, stock removal not permitted)
Current consumption	265 mA
Power consumption	3.3 W
Signal transmission	Cable ≤ 30 m
Connections	X1: Power supply and proximity sensor for protective cover X2: LAN (image data transmission to the control) P1: Sealing air for housing interior or air curtain (0.3 bar, supplied by DA 400) P2: Sealing air for protective cover air curtain (0.3 bar, supplied by DA 400) P3: Close the protective cover (6 to 10 bars, no DA required) P4: Open the protective cover (6 to 10 bars, no DA required)
Power supply	DC 12 V to 24 V
Operating temperature	0 °C to 40 °C
Storage temperature	-20 °C to 60 °C
Mass (without cable)	2.3 kg



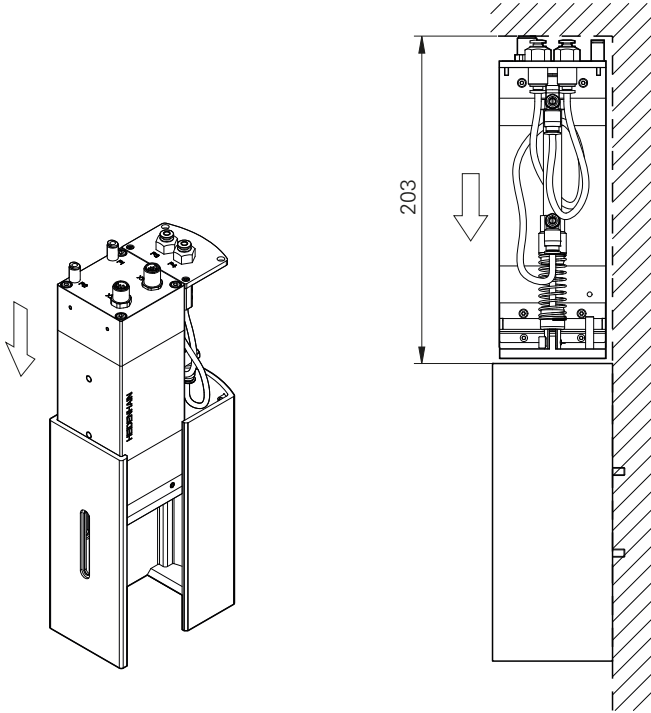

Mounting



Free space necessary for insertion

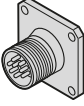

Electrical connection

Pin layout

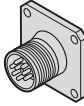
M12 flange socket												
												
	Power supply						Other signals					
	1	12	5	2	11	10	7	8	3	4	6	9
	U _P	0V	U _P	0V	U _P	0V	S ₁	S ₂	/	/	/	/
	Brown/ Green	White/ Green	White	Green	Blue	Brown	Red	Black	Gray	Pink	Violet	Yellow

M12 flange socket									
									
	Serial data transfer								
	5	8	6	4	7	1	2	3	
	D1+	D1-	D2+	D2-	D3+	D3-	D4+	D4-	

Adapter cables

PUR adapter cable Ø 6 mm [6 × (2 × 0.19 mm ²); A _P = 3 × 0.19 mm ²]		
12-pin M12 connector, female, and free cable end		801285-xx

PUR adapter cable Ø 6.8 mm [4 × (2 × 0.17 mm ²)]		
8-pin M12 connector, female, and RJ45 connector		1156708-xx

HEIDENHAIN

DR. JOHANNES HEIDENHAIN GmbH

Dr.-Johannes-Heidenhain-Straße 5

83301 Traunreut, Germany

☎ +49 8669 31-0

FAX +49 8669 32-5061

E-mail: info@heidenhain.de

www.heidenhain.de

This Product Information supersedes all previous editions, which thereby become invalid. The basis for ordering from HEIDENHAIN is always the Product Information document edition valid when the order is made.



Further information:

Comply with the requirements described in the following documents to ensure the correct operation of the encoder:

- TNC 640 HSCI brochure 896020-xx
- Mounting Instructions 1201668-xx
- Cables and Connectors brochure 1206109-xx